



10623 Roselle Street, San Diego, CA 92121 • (858) 550-9559 • FAX (858) 550-7322
contactus@accessio.com • www.accessio.com

MODEL USB-DIO24-CTR6 and MODEL USB-DIO-24

**24 Channel Digital I/O Module
with two 82C54 Counter/Timer Chips**

USER MANUAL

Notice

The information in this document is provided for reference only. ACCES does not assume any liability arising out of the application or use of the information or products described herein. This document may contain or reference information and products protected by copyrights or patents and does not convey any license under the patent rights of ACCES, nor the rights of others.

Printed in USA. Copyright © by ACCES I/O Products Inc, 10623 Roselle Street, San Diego, CA 92121-1506. All rights reserved.

WARNING!!

ALWAYS CONNECT AND DISCONNECT YOUR FIELD CABLING WITH THE COMPUTER POWER OFF. ALWAYS TURN COMPUTER POWER OFF BEFORE INSTALLING A CARD. CONNECTING AND DISCONNECTING CABLES, OR INSTALLING CARDS INTO A SYSTEM WITH THE COMPUTER OR FIELD POWER ON MAY CAUSE DAMAGE TO THE I/O CARD AND WILL VOID ALL WARRANTIES, IMPLIED OR EXPRESSED.

Warranty

Prior to shipment, ACCES equipment is thoroughly inspected and tested to applicable specifications. However, should equipment failure occur, ACCES assures its customers that prompt service and support will be available. All equipment originally manufactured by ACCES which is found to be defective will be repaired or replaced subject to the following considerations.

Terms and Conditions

If a unit is suspected of failure, contact ACCES' Customer Service department. Be prepared to give the unit model number, serial number, and a description of the failure symptom(s). We may suggest some simple tests to confirm the failure. We will assign a Return Material Authorization (RMA) number which must appear on the outer label of the return package. All units/components should be properly packed for handling and returned with freight prepaid to the ACCES designated Service Center, and will be returned to the customer's/user's site freight prepaid and invoiced.

Coverage

First Three Years: Returned unit/part will be repaired and/or replaced at ACCES option with no charge for labor or parts not excluded by warranty. Warranty commences with equipment shipment.

Following Years: Throughout your equipment's lifetime, ACCES stands ready to provide on-site or in-plant service at reasonable rates similar to those of other manufacturers in the industry.

Equipment Not Manufactured by ACCES

Equipment provided but not manufactured by ACCES is warranted and will be repaired according to the terms and conditions of the respective equipment manufacturer's warranty.

General

Under this Warranty, liability of ACCES is limited to replacing, repairing or issuing credit (at ACCES discretion) for any products which are proved to be defective during the warranty period. In no case is ACCES liable for consequential or special damage arriving from use or misuse of our product. The customer is responsible for all charges caused by modifications or additions to ACCES equipment not approved in writing by ACCES or, if in ACCES opinion the equipment has been subjected to abnormal use. "Abnormal use" for purposes of this warranty is defined as any use to which the equipment is exposed other than that use specified or intended as evidenced by purchase or sales representation. Other than the above, no other warranty, expressed or implied, shall apply to any and all such equipment furnished or sold by ACCES.

Table of Contents

Chapter 1: Introduction	5
Features	5
Applications	5
Functional Description	6
Counter/Timers	6
Figure 1-1: Block Diagram	7
Ordering Guide	8
Model Options	8
Special Order	8
Customization and Special Functions	8
Included with your board	8
Table 1-1: Optional Accessories	9
Figure 1-2: USB-DIO24-CTR6 Enclosure Label	10
Figure 1-3: USB-DIO-24 Enclosure Label	10
Chapter 2: Installation	11
Software CD Installation	11
Windows	11
Linux	11
Hardware Installation	11
Chapter 3: Hardware Details	12
Option Selections	12
Figure 3-1: Option Selection Map	12
Figure 3-2: UTBK-50 Dimensional Drawing	12
USB Connector	13
DC Power Jack (Optional)	13
50 Pin Box Header	13
Pull-Up / Pull-Down Configuration Jumpers	13
Vccio	13
Chapter 4: USB Address Information	14
Chapter 5: Programming	15
Chapter 6: Connector Pin Assignments	16
Table 6-1: P3 Connector Pin Assignments	16
Chapter 7: Specifications	17
Table 7-1: Vccio Logic Levels	17
Appendix A: 8254 Counter/Timer	18
Customer Comments	20

Chapter 1: Introduction

Features

- 24 lines of digital I/O
- High-speed USB 2.0 device, USB 3.0 and 1.1 compatible
- Two 8-bit ports and two 4-bit ports each software configurable for input or output
- Field selectable CMOS (+5V) or LVTTL (3.3V) Vccio signal levels
- CMOS: All 24 I/O lines buffered with 32 mA sink and source
- LVTTL: All 24 I/O lines buffered with 24 mA sink and source
- Two 82C54 counters with all pins available at I/O connector
- Each port field configurable as pull-up, pull-down, or no-bias
- Powered via USB cable; optional external power supply for sourcing higher total current
- Vccio at connector for general purpose use, protected by polyfuse
- Standard 50 pin male IDC header compatible with Industry-Standard I/O Racks such as Gordos, OPTO22, Potter & Brumfield
- PC/104 size (3.550 by 3.775 inches)
- Rugged, steel, industrial enclosure (4 by 4 by 1.25 inches)

Applications

- Automatic Test Systems
- Laboratory Automation
- Robotics
- Machine Control
- Security Systems, Energy Management
- Relay Monitoring and Control
- Parallel Data Transfer to PC
- Sensing Switch Closures or DTL, LVTTL and CMOS Logic
- Driving Indicator Lights or Recorders

Functional Description

This USB board is an ideal solution for adding portable, easy-to-install digital I/O and counter capabilities to any computer with a USB port. The board is a USB 2.0 high speed device and is fully compatible with USB 3.0 and USB 1.1 ports. The card is plug-and-play allowing quick connect/disconnect whenever you need additional I/O on your USB port.

The board features 24 bits of CMOS/LVTTL-compatible digital I/O with high-current capabilities and two 82C54 counter/timers. Each digital port can be programmed to accept inputs or to drive outputs. Groups of two 8-bit ports and two 4-bit ports are designated as port A, B, CHi and CLo. Power is supplied to the card via the USB cable. For higher current sourcing capabilities, external power may be used. The I/O wiring connections are via an industry standard 50-pin male connector and a variety of optional terminal block adapter cards. For external circuits, fused +5V (or 3.3V) DC power is available on pin 49 of the connector. The resettable fuse is rated at 0.5A.

All 24 I/O lines are buffered by a type 74LVC8T245 tristate buffer transceiver capable of operating in CMOS (+5V) or LVTTL (+3.3V) modes. The mode is set for all pins simultaneously via an onboard jumper. When using CMOS mode the outputs can sink or source 32 mA. In LVTTL mode the outputs can sink or source 24mA. The 24 bits are divided into four ports: two 8-bit ports (Port A, Port B), and two 4-bit ports (Port CLo, Port CHi). Each port can be configured independently via onboard jumpers for pull-up, pull-down, or no bias. Each port can also be configured independently, via software command, for use as inputs or outputs.

The board is available in two models, one with two 8254 counter/timer chips, and one without. The unit without counters is optimally suited for use with industry standard solid state module mounting racks. Because this version does not place any counter signals on pins normally reserved for Ground, it provides a perfectly compatible 50-pin IDC connection.

Unlike most USB digital I/O products which primarily use a human interface device (HID) driver, we provide an easy to use, Windows-based, custom function driver optimized for maximum data throughput. This approach exposes the full functionality of the hardware along with maximizing the advantage of using the high-speed USB 2.0 bus and allows your application software to achieve up to 4000 transactions per second (compared to 50 or 100 per second typical when using HID drivers).

The board is designed to be used in rugged industrial environments but is small enough to fit nicely onto any desk or testing station. The board is PC/104 size (3.550 by 3.775 inches) and ships inside a steel powder-coated enclosure with an anti-skid bottom (4 by 4 by 1.25 inches).

Counter/Timers

On the board are two 82C54 counter chips that each include three 16-bit counter/timers with each input, output and gate signal buffered, pulled up, and brought to the I/O connector. They can be connected for use as event counters, frequency output, pulse width, and frequency measurement.

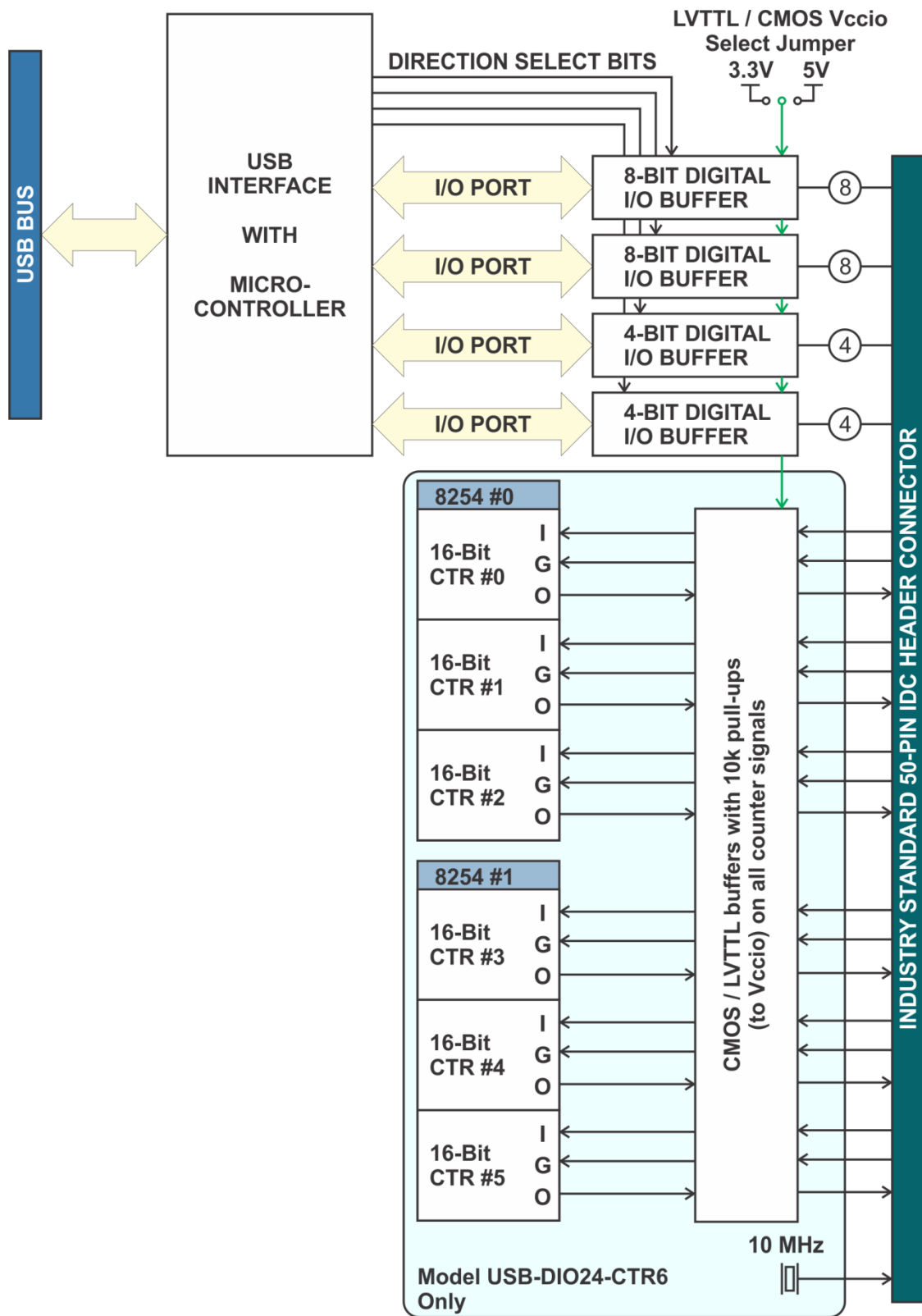

Figure 1-1: Block Diagram

Ordering Guide

- USB-DIO24-CTR6 USB 24-channel digital input/output module with two 82C54's
- USB-DIO-24 USB 24-channel digital input/output module

For use with solid-state module mounting racks, order model# USB-DIO-24-PR, and consider adding a cable, model# CAB50-xx (where xx is length in feet)

Model Options

- -PR Ext. regulated 5V power and AC/DC adapter
- -ST External power connection via screw terminals
- -OEM Board only (no enclosure or terminal board)
- -RoHS Compliant board
- -T Extended operating temp. -40°C to +85°C

Special Order

- -S0x Contact factory with your special requirement. Examples of special orders would be conformal coating, latching I/O headers, and/or single 8254 installed, etc.

Customization and Special Functions

Due to the nature of our USB modules, many special functions can be implemented with a combination of custom firmware and an associated DLL entry point, for little to no NRE. Functions such as quadrature input, pulse-width modulated outputs, even input de-bouncing. Call us to discuss your requirement!

Included with your board

The following components are included with your shipment, depending on options ordered. Please take the time now to ensure that no items are damaged or missing.

- USB Module in labeled enclosure with an anti-skid bottom
- 6' USB 2.0 cable

<ul style="list-style-type: none"> • CAB50F-6 	Six-foot ribbon cable assembly with 50-pin female connectors	
<ul style="list-style-type: none"> • CAB50-6 	Six-foot ribbon cable assembly with a 50-pin female header connector and a 50-pin female edge connector, perfect for use with industry standard solid state module mounting racks	
<ul style="list-style-type: none"> • IIB-24 	Adds 24 channels of optically isolated inputs	
<ul style="list-style-type: none"> • UTBK-50 	Direct connect, universal 50-pin removable screw terminal board	
<ul style="list-style-type: none"> • STB-50 	Screw terminal board, typically ships with standoffs but can also mount on SNAP-TRACK or DIN-SNAP	
<ul style="list-style-type: none"> • STB-50U Kit 	Spring cage terminal board with PC/104 compatible mounting, mounts on enclosure of USB module and includes short ribbon cable.	
<ul style="list-style-type: none"> • DIN-SNAP-6 	Six inch length of SNAP-TRACK with two clips, for mounting one STB-50 screw terminal board on a DIN rail	
<ul style="list-style-type: none"> • DIN-SNAP 	One foot length of SNAP-TRACK with four clips, for mounting up to two STB-50 screw terminal boards on a DIN rail	
<ul style="list-style-type: none"> • MP104-DIN 	DIN-rail mounting adapter plate for affixing any USB/104 module to a DIN-rail	

Table 1-1: Optional Accessories

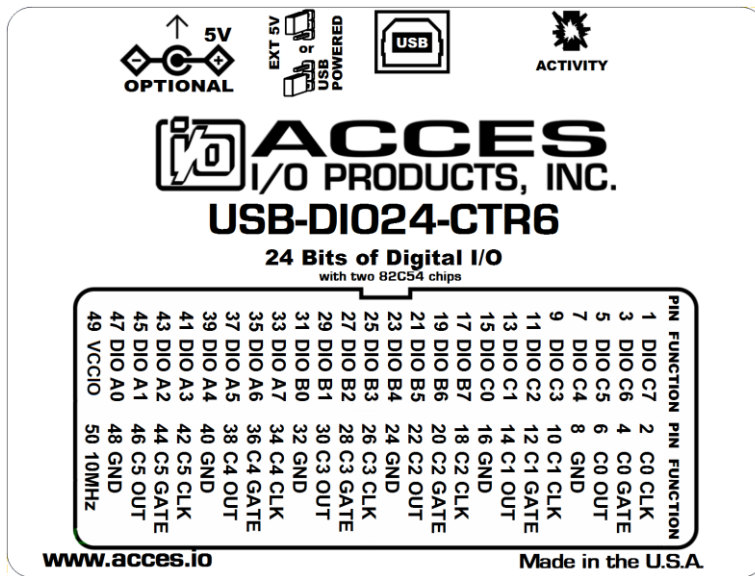

Figure 1-2: USB-DIO24-CTR6 Enclosure Label

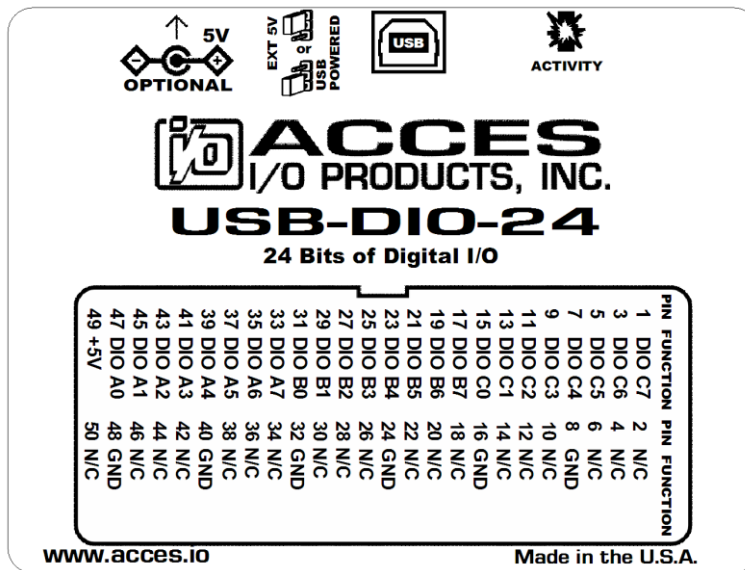

Figure 1-3: USB-DIO-24 Enclosure Label

Chapter 2: Installation

A printed Quick-Start Guide (QSG) is packed with the board for your convenience. If you've already performed the steps from the QSG, you may find this chapter to be redundant and may skip forward to begin developing your application.

Software CD Installation

The software provided with this board is contained on one CD and must be installed onto your **hard disk prior to use**. To do this, perform the following steps as appropriate for your operating system. Substitute the appropriate drive letter for your drive where you see D: in the examples below.

Windows

- a. Place the CD into your CD-ROM drive.
- b. The install program automatically run. If the install program does not run, click START | RUN and type `D:\INSTALL.` click OK or press `Enter`.
- c. Follow the on-screen prompts to install the software for this board.

Linux

- a. Please refer to linux.htm on the CD for information on installing under Linux.

Hardware Installation

Please install the software package before plugging the hardware into the system. Refer to the printed I/O Quick Start Guide included with your board which can also be found on the CD, for specific, quick steps, to complete the hardware and software installation.

Caution! ESD

A single static discharge can damage your card and cause premature failure! Please follow all reasonable precautions to prevent a static discharge such as grounding yourself by touching any grounded surface **prior to touching the card.**

Chapter 3: Hardware Details

Option Selections

Refer to the settings program on the CD provided with the board. Also, refer to the Block Diagram and the Option Selection Map when reading this section of the manual.

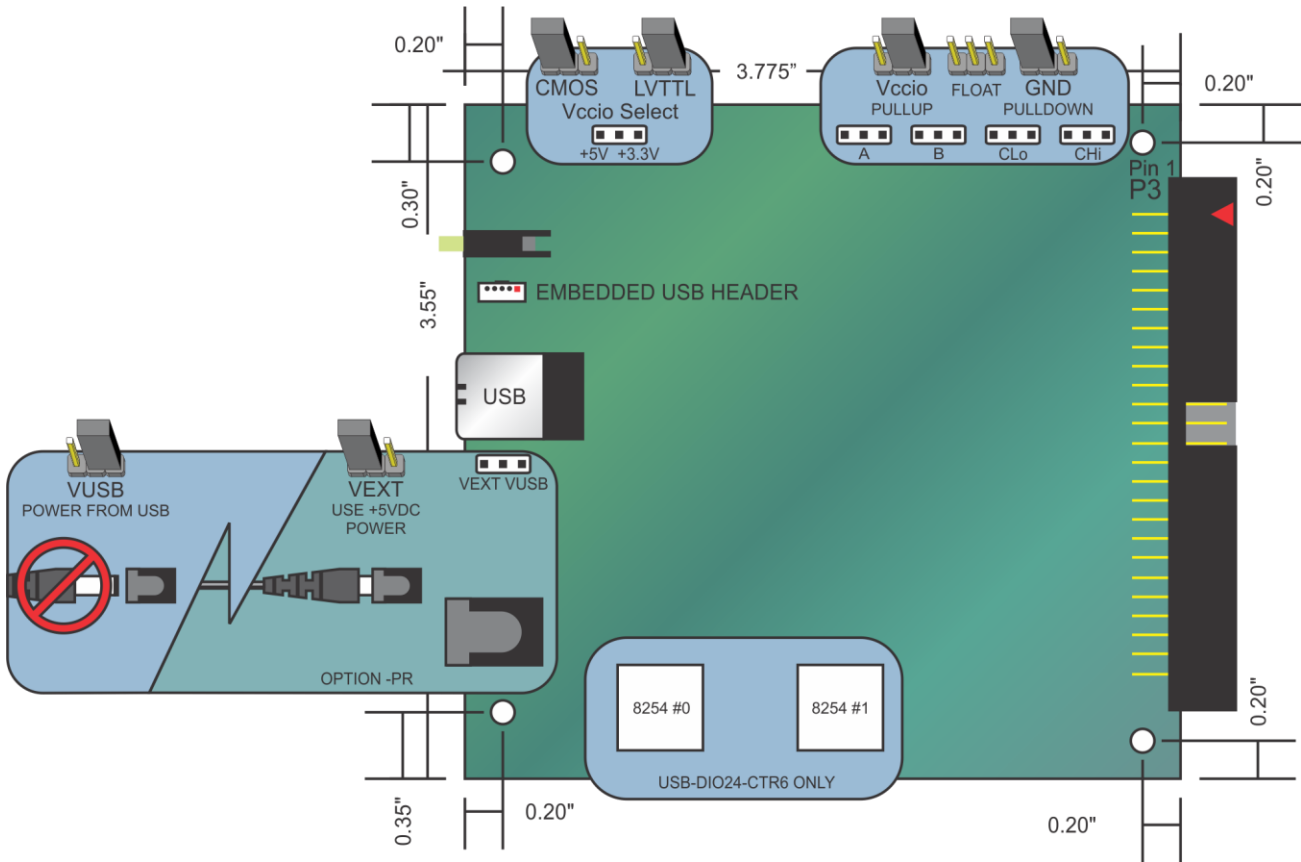

Figure 3-1: Option Selection Map

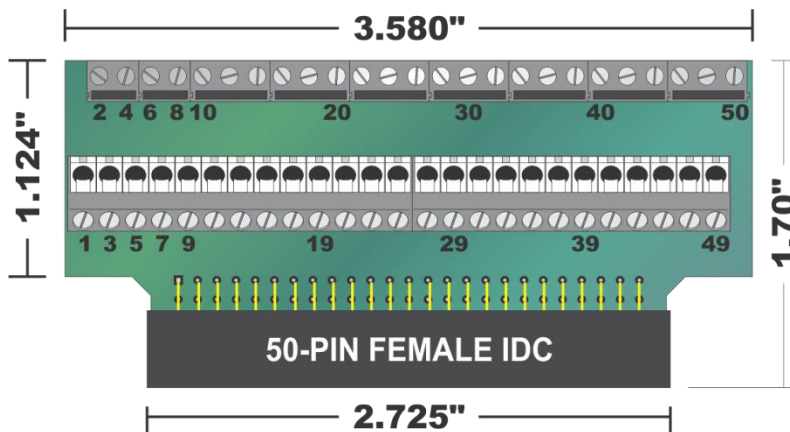

Figure 3-2: UTBK-50 Dimensional Drawing

USB Connector

The USB connector is a Type B connector and mates with the cable provided. The USB port provides communication signals along with +5 VDC power. The board can be powered from the USB port or, if needed for higher current applications, an external power supply can be used.

LED

The LED on the front of the enclosure is used to indicate power and data transmissions. When the LED is in an illuminated steady green state, this signifies that the board is successfully connected to the computer and has been detected and configured by the operating system. When the LED flashes continuously, this signifies that there is data being transmitted over the USB bus.

DC Power Jack (Optional)

This is an option for high current applications when more current is needed than what your computer can provide on the USB port (typically 500 mA). The DC jack has a 2.00mm post on board and is designed to be used with the regulated 5VDC AC/DC external power supply that ships with this option. When using external power, switch the jumper located near the USB connector to VEXT, otherwise when the jumper is in the VUSB position current is drawn from the USB port (please consult the option selection map for a visual reference).

50 Pin Box Header

The 50 pin box header has standard 0.100" spacing between pins and is keyed to prevent improper connections. It can be used with standard IDC type ribbon cables or optionally available screw terminal boards, some of which plug directly into the box header.

Pull-Up / Pull-Down Configuration Jumpers

The 24 bits are divided into four ports: two 8-bit ports (Port A, Port B), and two 4-bit ports (Port CLo, Port CHi). Each port can be configured independently via onboard jumpers for pull-up or pull-down, via 10Kohm resistor packs, or no bias, by removing the jumper. Pull-ups are very common for dry-contact monitoring, while pull-downs prevent the activation of external inputs and devices during the power-up and reset sequences, before software can take over. However, due to the 10K resistor packs, any un-used input will not have suppressed cross-talk. For pull-ups (most common), install these jumpers in the PULLUP position. For pull-downs, install these jumpers in the PULLDOWN position. For neither, remove these jumpers. The board ships from the factory with all ports configured with pull-ups.

Vccio

There are two Vccio levels available on this board. They are 5V (CMOS) and 3.3V (LVTTTL). Vccio applies to all DIO, counter/timer, and external control signals on the connector. Install the jumper in the desired Vccio position. The board ships from the factory configured for +5V (CMOS) operation.

Chapter 4: USB Address Information

Use the provided driver to access the USB board. This driver will allow you to determine how many supported USB devices are currently installed, and each device's type. This information is returned as a Vendor ID (VID), Product ID (PID) and Device Index.

The board's VID is "0x1605".

The PID for the USB-DIO24-CTR6 is 0x8006

The PID for the USB-DIO-24 is 0x8005

The Device Index is determined by how many of the device you have in your system, and provides a unique identifier allowing you to access a specific board at will.

Chapter 5: Programming

The onboard firmware of the device can be controlled directly using any USB compatible operating system driver (such as VISA, or libusb) but we provide a convenient linux and Windows compatible wrapper library. In Windows, the AIOUSB.DLL (available in both 32-bit and 64-bit versions) provides a wide variety of functions for your use.

The following functions represent those most commonly used for this device. For more details, consult the USB Software Reference Manual (.pdf), or the linux /doc/ trees, as appropriate.

```
unsigned long DIO_Configure(DeviceIndex, bTristate, pOutMask, pData)
unsigned long DIO_WriteAll(DeviceIndex,pData)
unsigned long DIO_ReadAll(DeviceIndex,Buffer)
unsigned long CTR_8254ModeLoad(DeviceIndex, BlockIndex, CounterIndex,Mode,
LoadValue)
unsigned long CTR_8254Read(DeviceIndex, BlockIndex, CounterIndex, pReadValue)
```

Chapter 6: Connector Pin Assignments

A 50-pin male header connector protrudes through a cutout in the enclosure for I/O connections. Connector pin assignments are listed below.

IDC 50-Pin Header Male

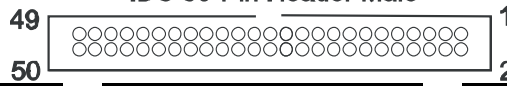

PIN	FUNCTION	PIN	MODEL USB-DIO24-CTR6	PIN	MODEL USB-DIO-24
1	PC7	2	IPC0CLK	2	N/C
3	PC6	4	IPC0GATE	4	N/C
5	PC5	6	OPC0OUT	6	N/C
7	PC4	8	GROUND	8	GROUND
9	PC3	10	IPC1CLK	10	N/C
11	PC2	12	IPC1GATE	12	N/C
13	PC1	14	OPC1OUT	14	N/C
15	PC0	16	GROUND	16	GROUND
17	PB7	18	IPC2CLK	18	N/C
19	PB6	20	IPC2GATE	20	N/C
21	PB5	22	OPC2OUT	22	N/C
23	PB4	24	GROUND	24	GROUND
25	PB3	26	IPC3CLK	26	N/C
27	PB2	28	IPC3GATE	28	N/C
29	PB1	30	OPC3OUT	30	N/C
31	PB0	32	GROUND	32	GROUND
33	PA7	34	IPC4CLK	34	N/C
35	PA6	36	IPC4GATE	36	N/C
37	PA5	38	OPC4OUT	38	N/C
39	PA4	40	GROUND	40	GROUND
41	PA3	42	IPC5CLK	42	N/C
43	PA2	44	IPC5GATE	44	N/C
45	PA1	46	OPC5OUT	46	N/C
47	PA0	48	GROUND	48	GROUND
49	Fused VCCIO	50	10MHz Clock	50	N/C

Table 6-1: P3 Connector Pin Assignments

Chapter 7: Specifications

Digital I/O

Channels / Groups: 24 in two 8-bit and two 4-bit groups
Type: 8255 Mode 0 compatible
Logic Level: Vccio
Pull-up/down: 10kΩ, jumper selectable

Vccio

Voltage levels: Jumper selectable for 5V or 3.3V

Logic Levels	5V (CMOS)		3.3V (LVTTTL)	
Low Inputs	≤ 1.5V	≤ 2uA	≤ 0.8V	≤ 2uA
High Inputs	≥ 3.5V	≤ 2uA	≥ 2.0V	≤ 2uA
Low Outputs	≤ 0.55V	32mA	≤ 0.55V	24mA
High Outputs	≥ 3.8V	32mA	≥ 2.4V	24mA

Table 7-1: Vccio Logic Levels

Counter / Timers

Number / Type: Two 82C54 programmable interval counters
Counter size: 16-bit
Logic level: Vccio
On-board clock: 10MHz
Clock Pulse Width: High - 30ns (min)
Low - 40ns (min)

Bus Type

USB2.0 high-speed (480 Mb/s), USB3.0 and USB1.1 compatible

Power

Basic unit: 140 mA typical (no load)
+5 VDC from the USB bus or external power supply depending on user configuration. The USB bus is specified to provide 500 mA in most desktop environments. This gives you 360 mA available (500mA - 140mA = 360mA). If using more than a total of 500mA, use optional 5 VDC external power supply and remove VUSB jumper and place jumper on VEXT. Then plug in external power before plugging into USB port. This option will give you a total of 1000mA available.
Vccio resettable fuse at 0.5A located near the connector.

Environmental

Operating Temp.: 0 °C. to 70 °C. (-40°C to +85°C as a factory option)
Storage Temp.: -40 °C. to +85 °C.
Humidity: 5 to 90% RH, non-condensing.
Board Dimension: 3.550 x 3.775 inches.
Box Dimension: 4.00 x 4.00" x 1.25 inches.

Appendix A: 8254 Counter/Timer

These boards ship standard with two 82C54 counter(s) that each include three 16-bit counter/timers. Each counter can be programmed to any count as low as 1 or 2, and up to 65,536, depending on the mode chosen. For those interested in more detailed information, a full description can be found in the Intel (or equivalent manufacturer's) data sheet, provided in the /chipdocs directory on the Software Master CD.

Refer to Chapter 5: Programming, and the .html Driver Manual document installed by the Software Master CD for information on using the installed software driver for this board. The following data is provided only for reference, as it is unlikely to be needed when using the provided driver. Please note the block diagram description of how the 9 pins associated with 8254 counters are all independently brought to the I/O connector on this board.

Operational Modes

The 8254 modes of operation are described in the following paragraphs to familiarize you with the versatility and power of this device. For those interested in more detailed information, a full description of the 8254 programmable interval timer can be found in the Intel (or equivalent manufacturers') data sheets. The following conventions apply for use in describing operation of the 8254 :

Clock:	A positive pulse into the counter's clock input
Trigger:	A rising edge input to the counter's gate input
Counter Loading:	Programming a binary count into the counter

Mode 0: Pulse on Terminal Count

After the counter is loaded, the output is set low and will remain low until the counter decrements to zero. The output then goes high and remains high until a new count is loaded into the counter. A trigger enables the counter to start decrementing.

Mode 1: Retriggerable One-Shot

The output goes low on the clock pulse following a trigger to begin the one-shot pulse and goes high when the counter reaches zero. Additional triggers result in reloading the count and starting the cycle over. If a trigger occurs before the counter decrements to zero, a new count is loaded. This forms a retriggerable one-shot. In mode 1, a low output pulse is provided with a period equal to the counter count-down time.

Mode 2: Rate Generator

This mode provides a divide-by-N capability where N is the count loaded into the counter. When triggered, the counter output goes low for one clock period after N counts, reloads the initial count, and the cycle starts over. This mode is periodic, the same sequence is repeated indefinitely until the gate input is brought low. This mode also works well as an alternative to mode 0 for event counting.

Mode 3: Square Wave Generator

This mode operates like mode 2. The output is high for half of the count and low for the other half. If the count is even, then the output is a symmetrical square wave. If the count is odd, then the output is high for $(N+1)/2$ counts and low for $(N-1)/2$ counts. Periodic triggering or frequency synthesis are two possible applications for this mode. Note that in this mode, to achieve the square wave, the counter decrements by two for the total loaded count, then reloads and decrements by two for the second part of the wave form.

Mode 4: Software Triggered Strobe

This mode sets the output high and, when the count is loaded, the counter begins to count down. When the counter reaches zero, the output will go low for one input period. The counter must be reloaded to repeat the cycle. A low gate input will inhibit the counter.

Mode 5: Hardware Triggered Strobe

In this mode, the counter will start counting after the rising edge of the trigger input and will go low for one clock period when the terminal count is reached. The counter is retriggerable. The output will not go low until the full count after the rising edge of the trigger.

Customer Comments

If you experience any problems with this manual or just want to give us some feedback, please email us at: ***manuals@acesio.com***. Please detail any errors you find and include your mailing address so that we can send you any manual updates.



10623 Roselle Street, San Diego CA 92121

Tel. (858)550-9559 FAX (858)550-7322

www.acesio.com